

**Bermuda**  
**Log 186**  
**4000x5500 45mm**

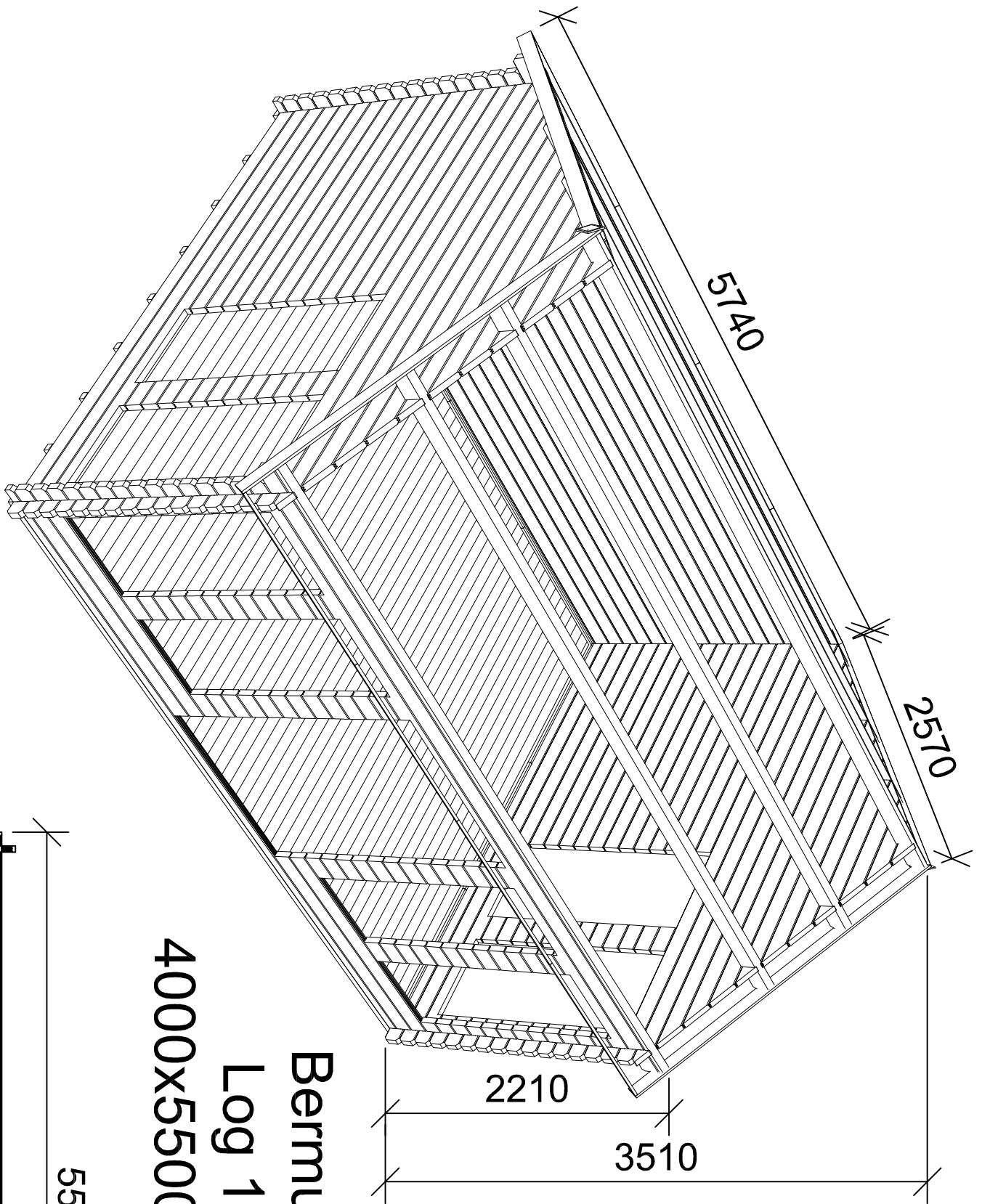

Bermuda

Log 186

4000x5500 45mm

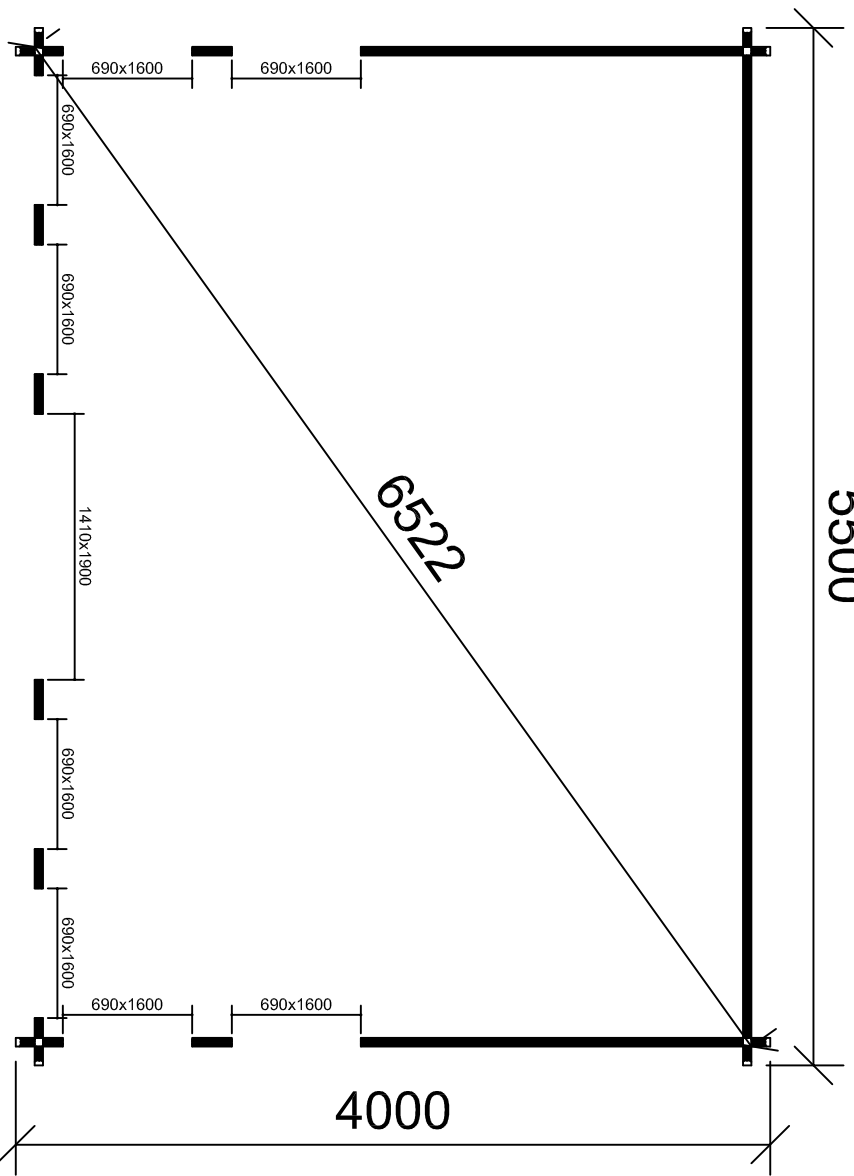
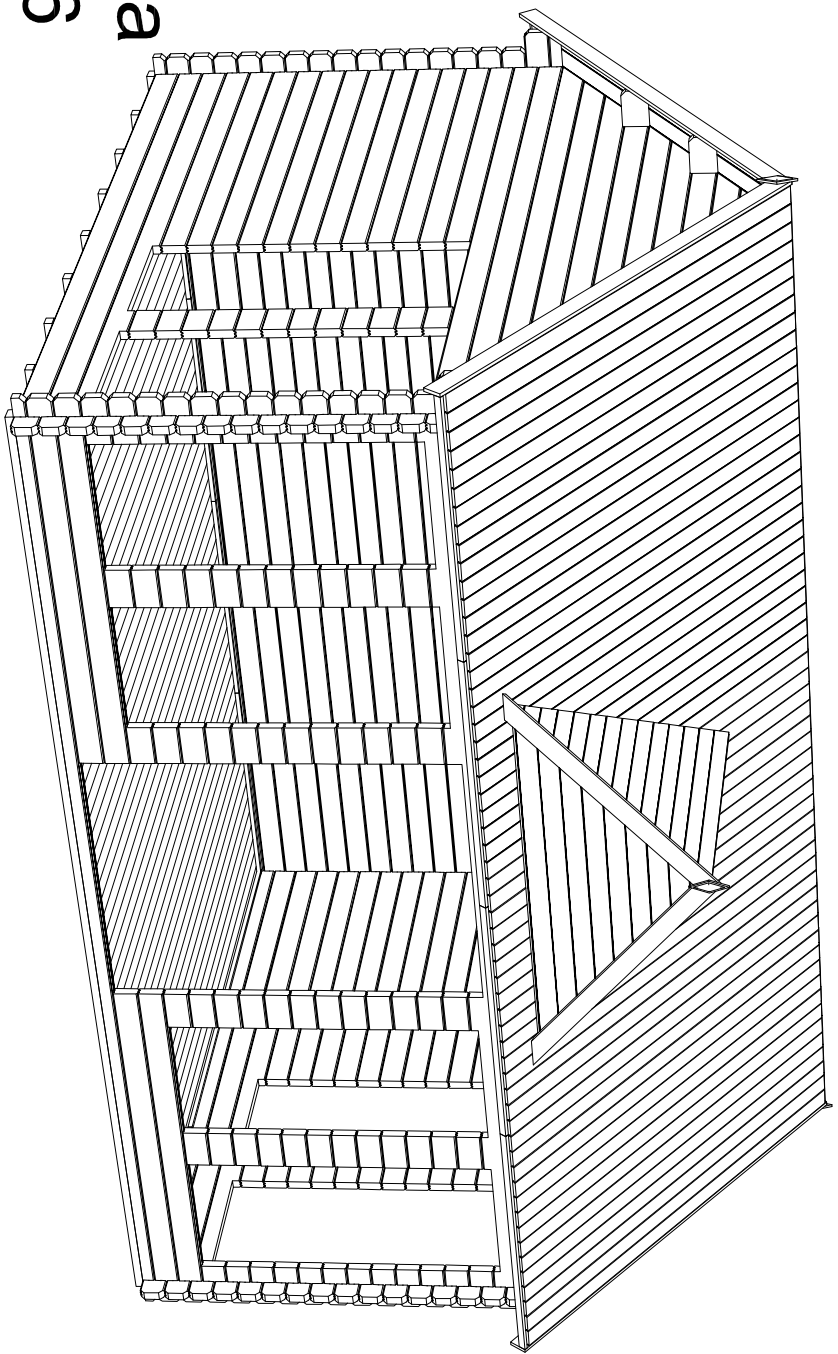

4 poz. ~ 20 meters

Bermuda  
Log 186  
4000x5500 45mm

Bermuda  
Log 186  
4000x5500 45mm

Bermuda  
Log 186  
4000x5500 45mm

3700

3800

5160

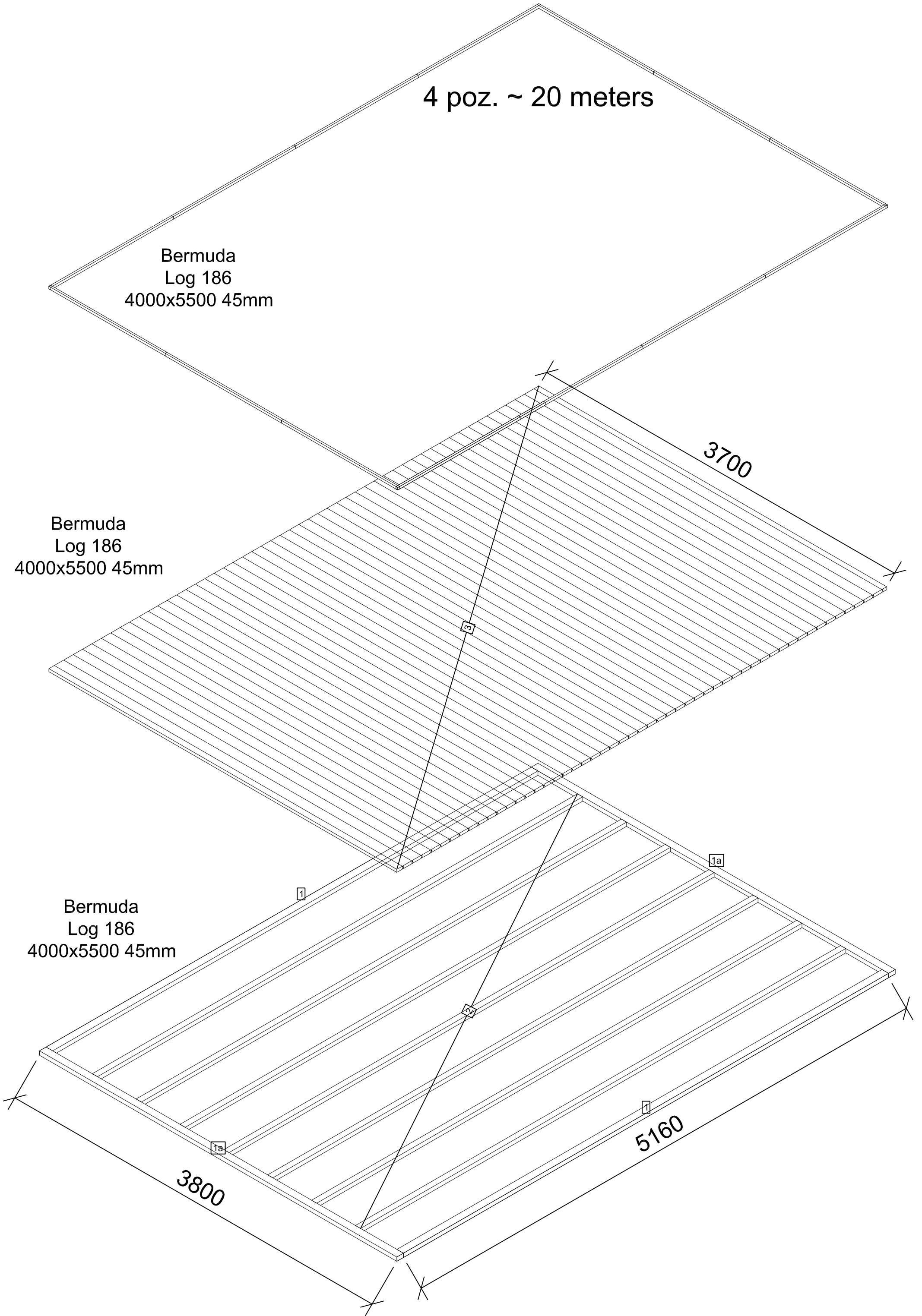

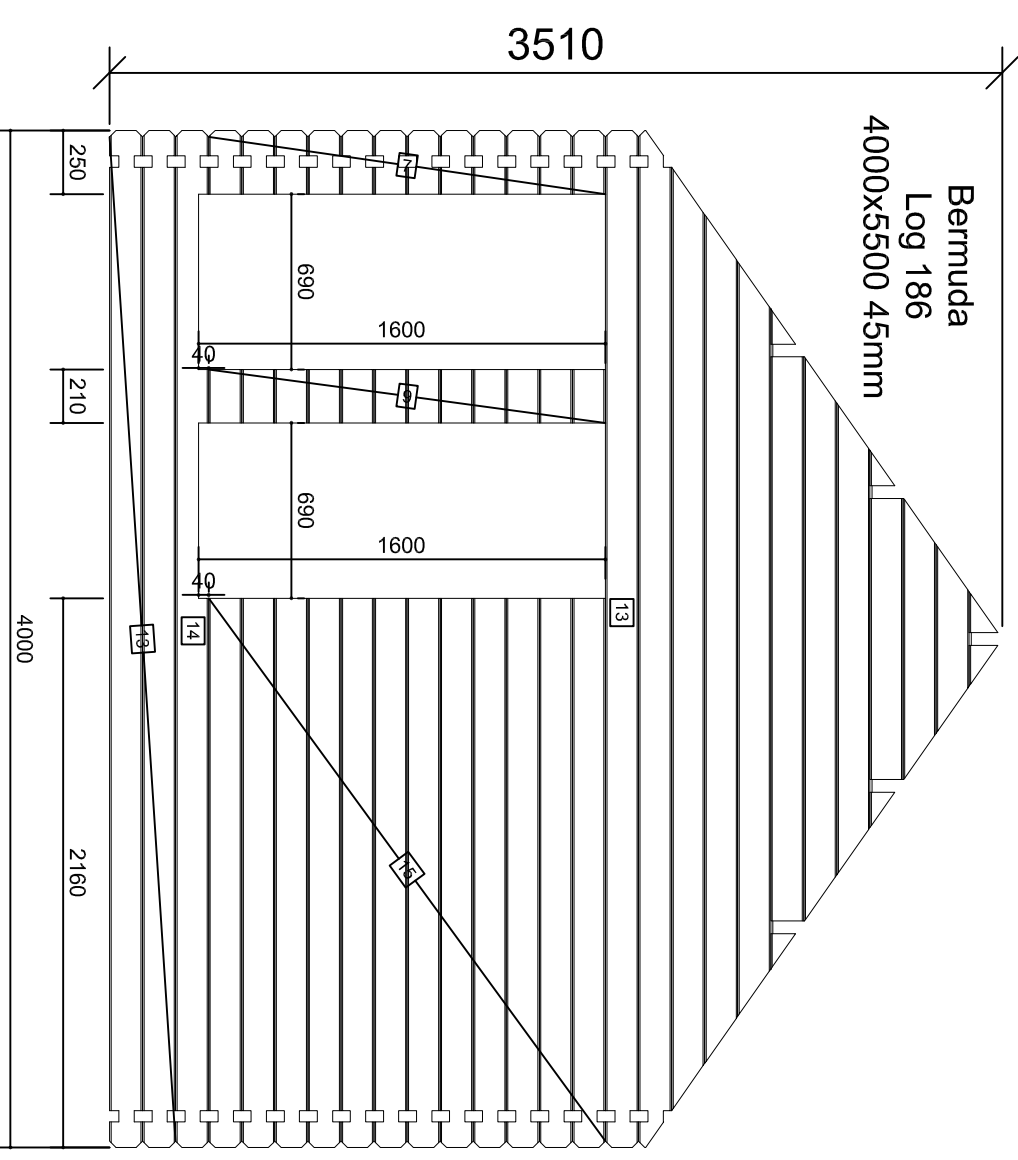
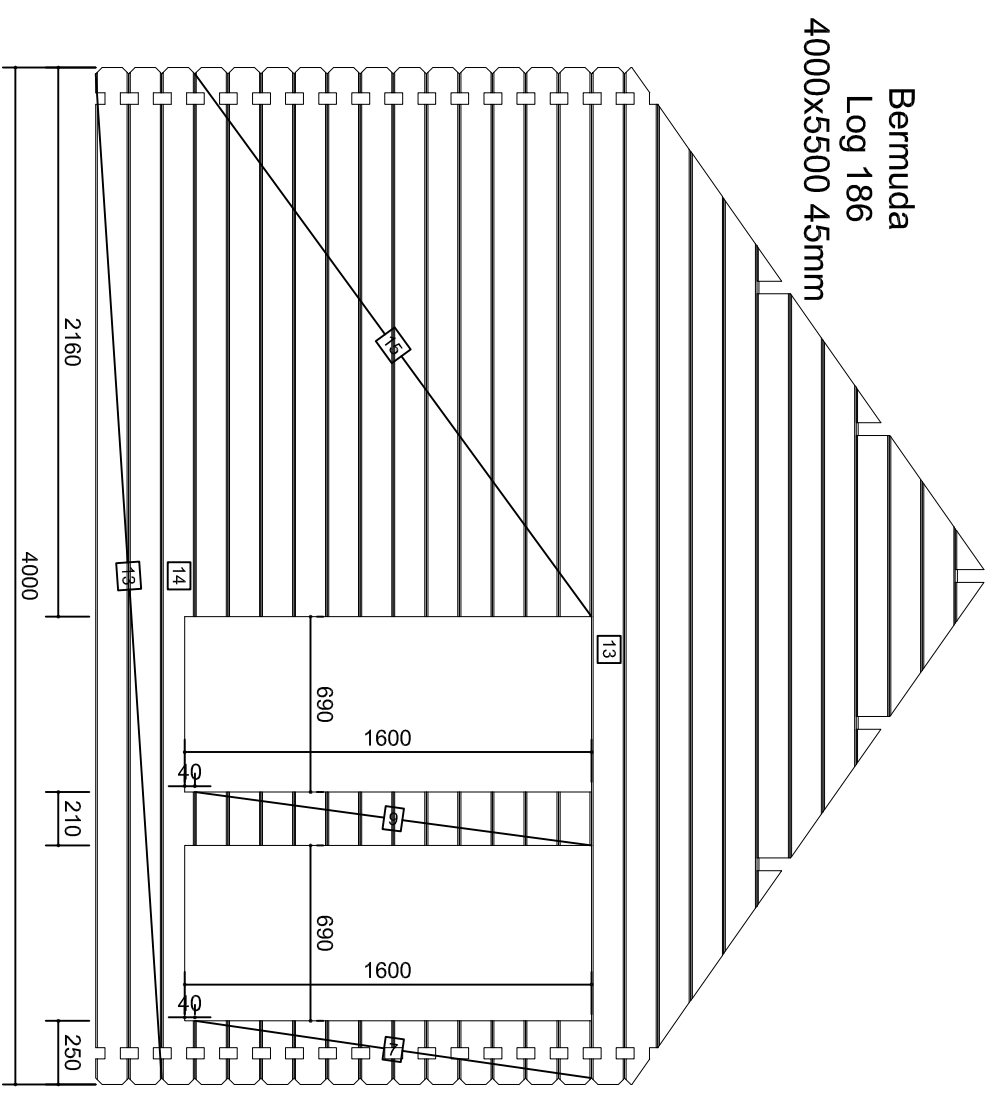
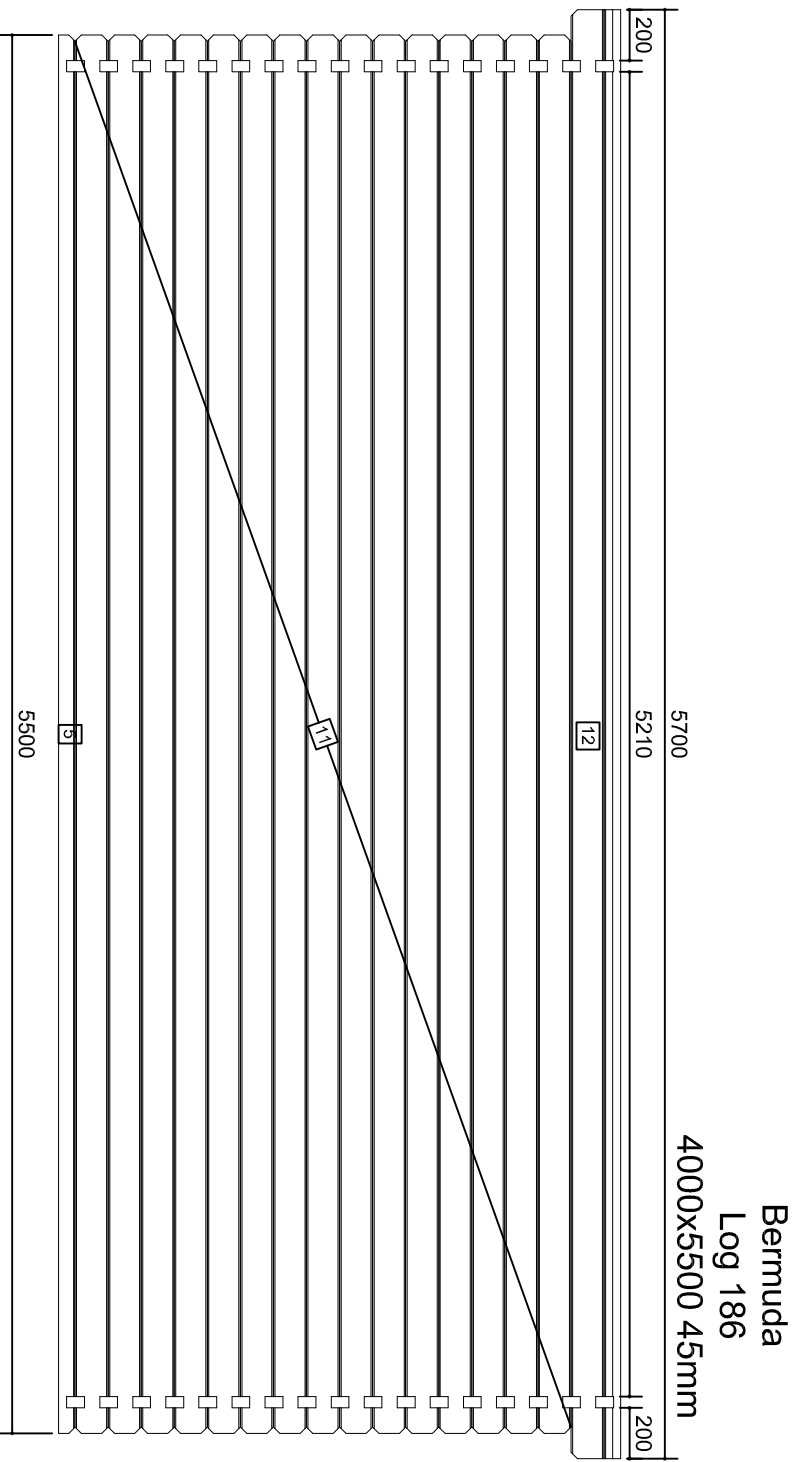
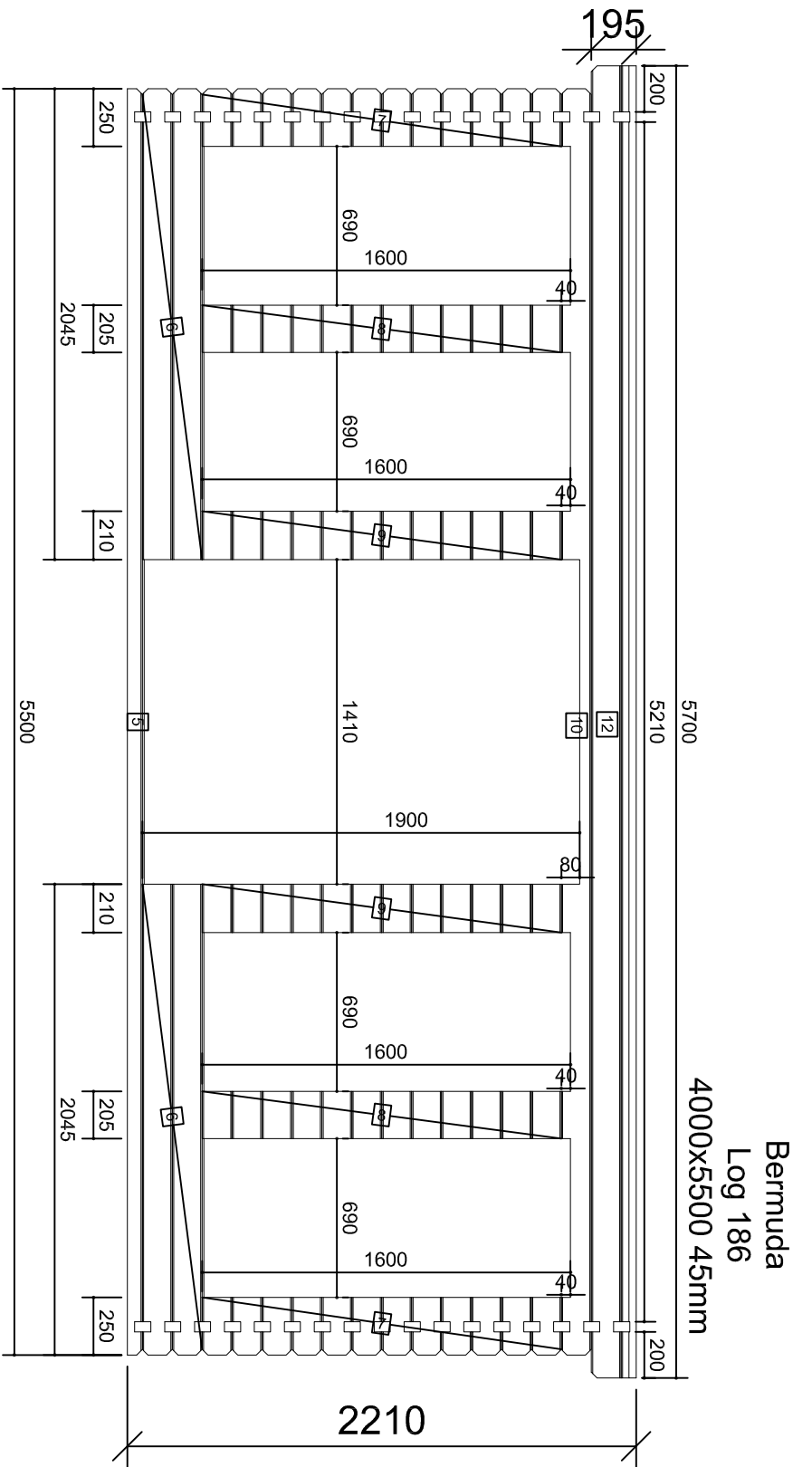

Bermuda

Log 186

2 vnt.

4000

4000x5500 45mm

3710

3339

2968

2226

1855

1113

742

161

50

136

136

130

1412

55°

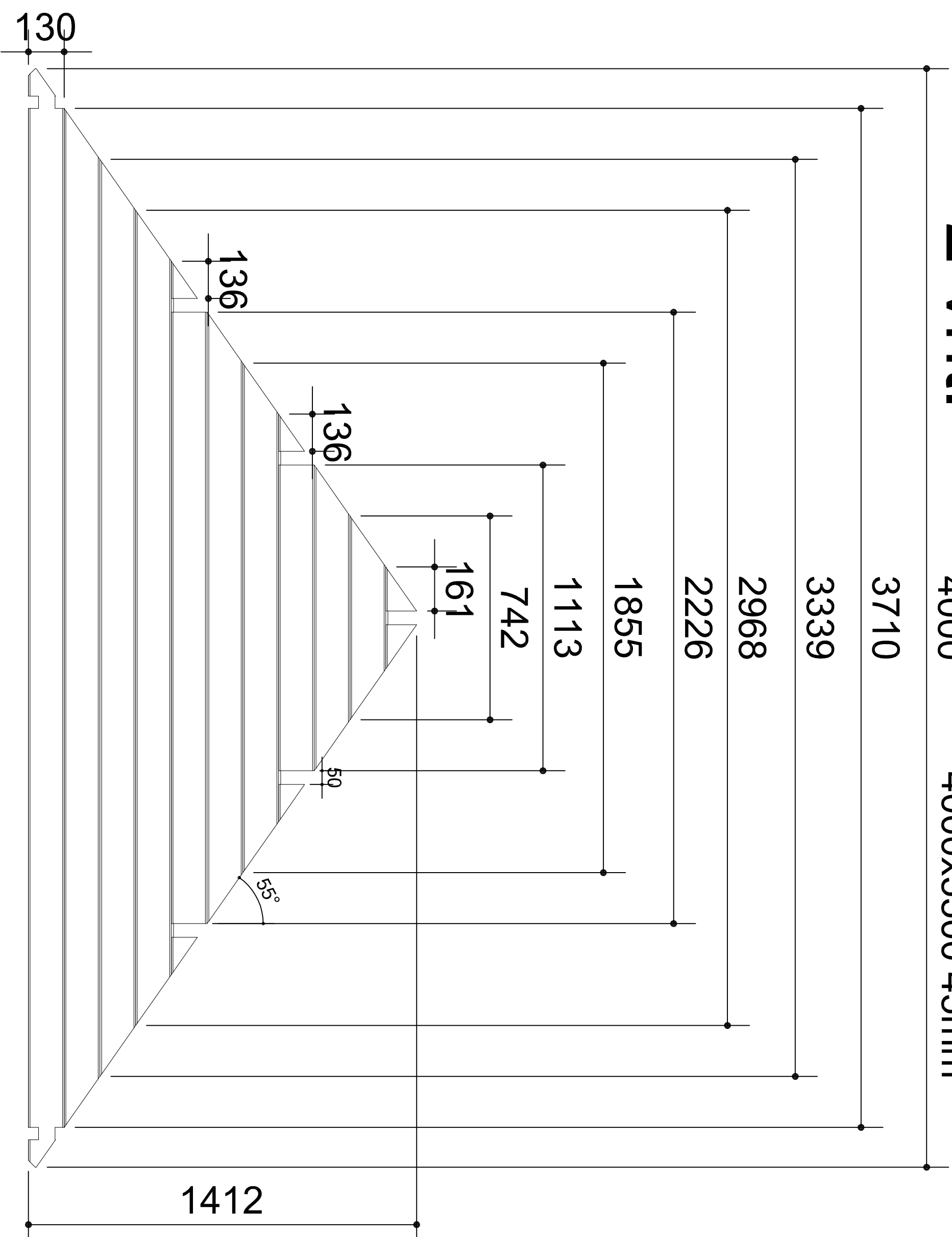

# Bermuda

## Log 186

### 4000x5500 45mm

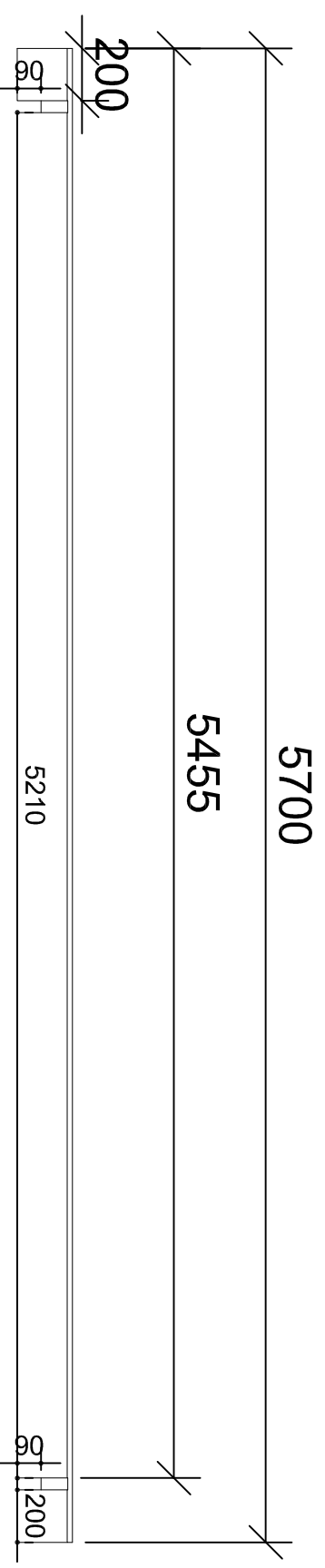
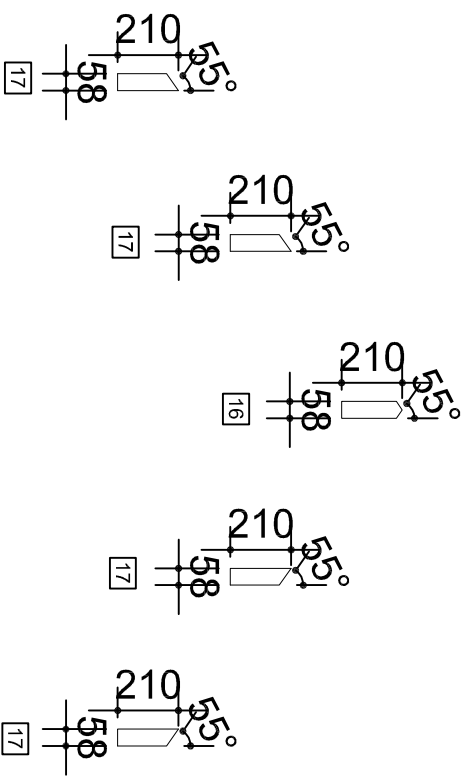
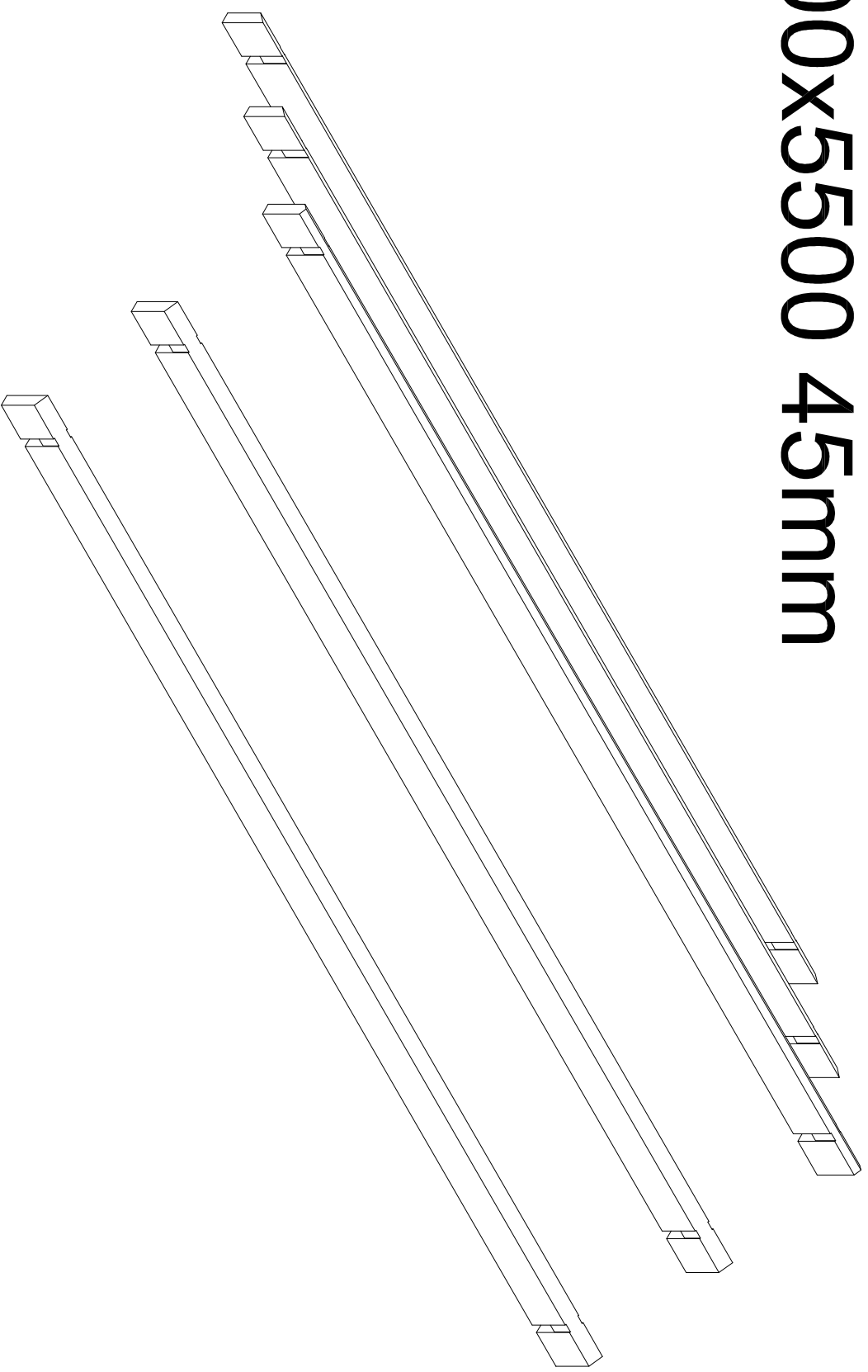
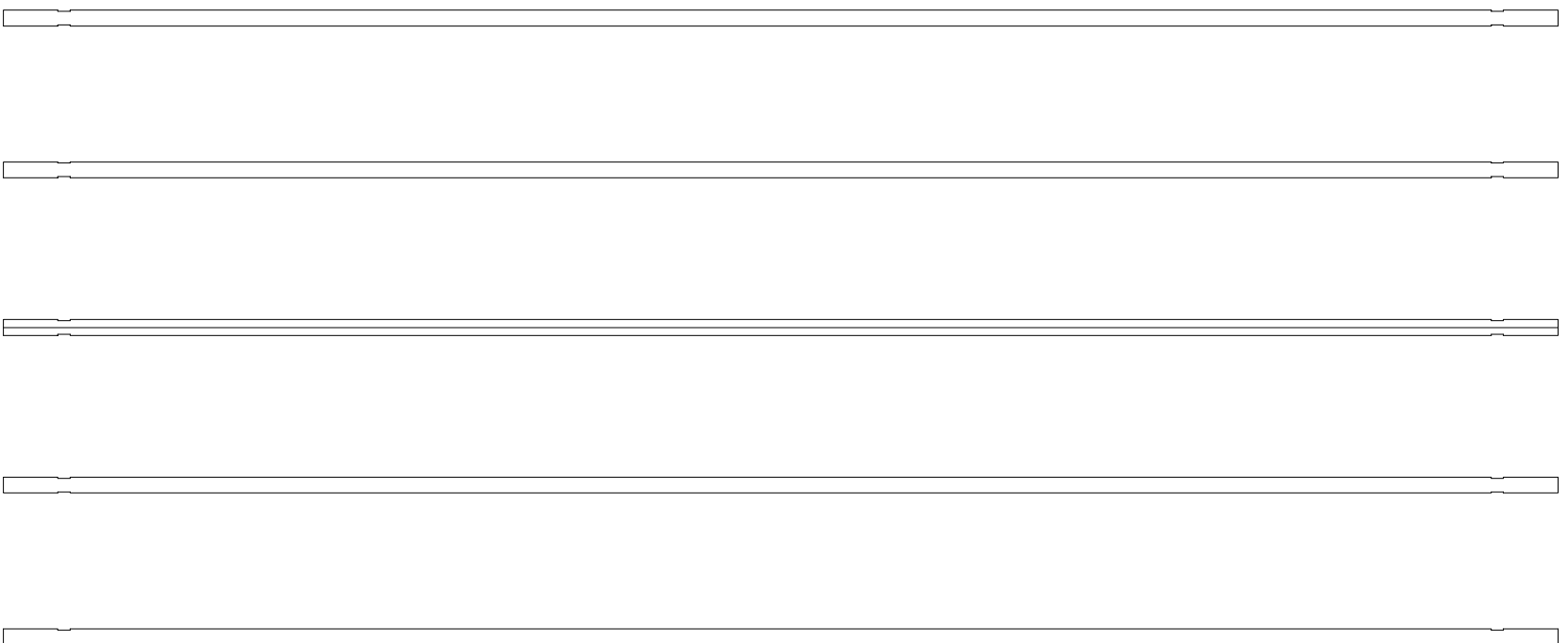

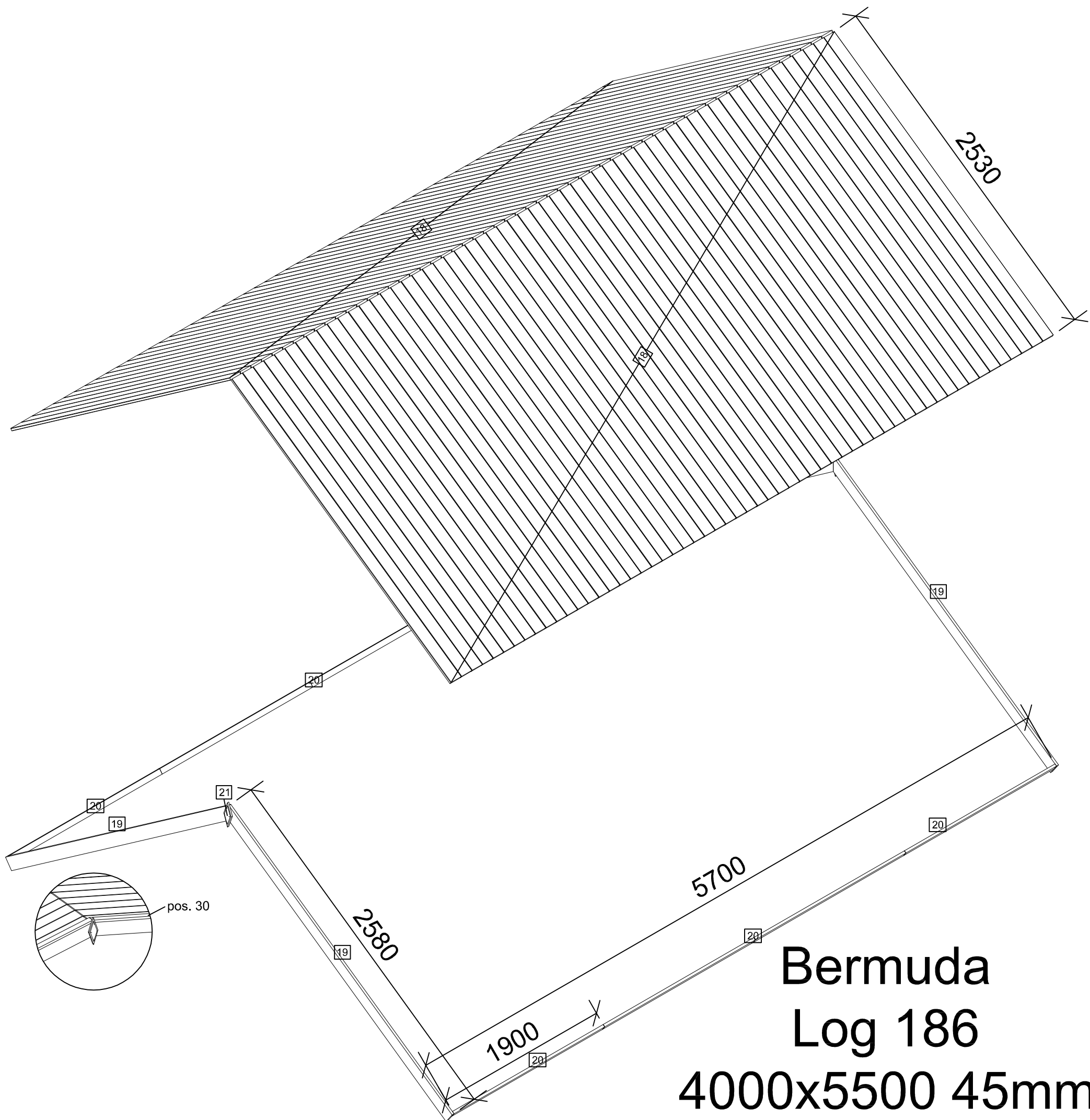

**Bermuda**  
**Log 186**  
**4000x5500 45mm**

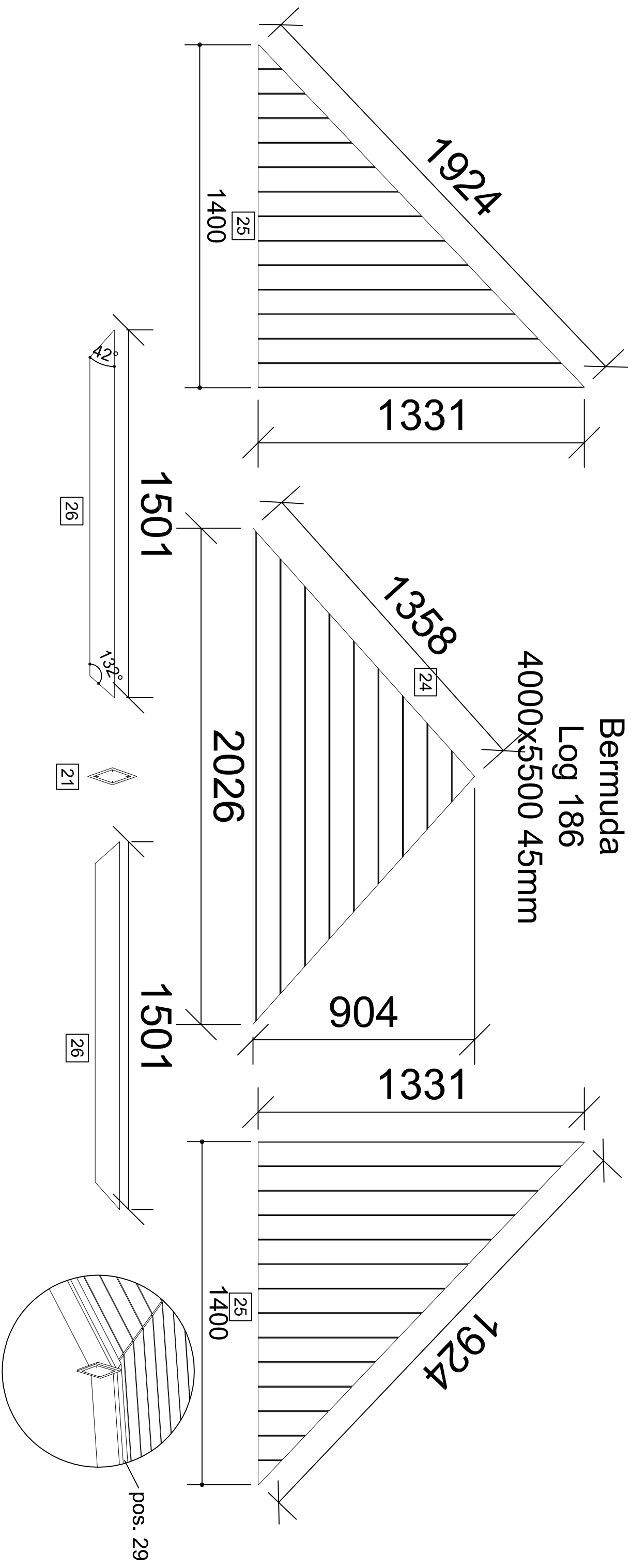





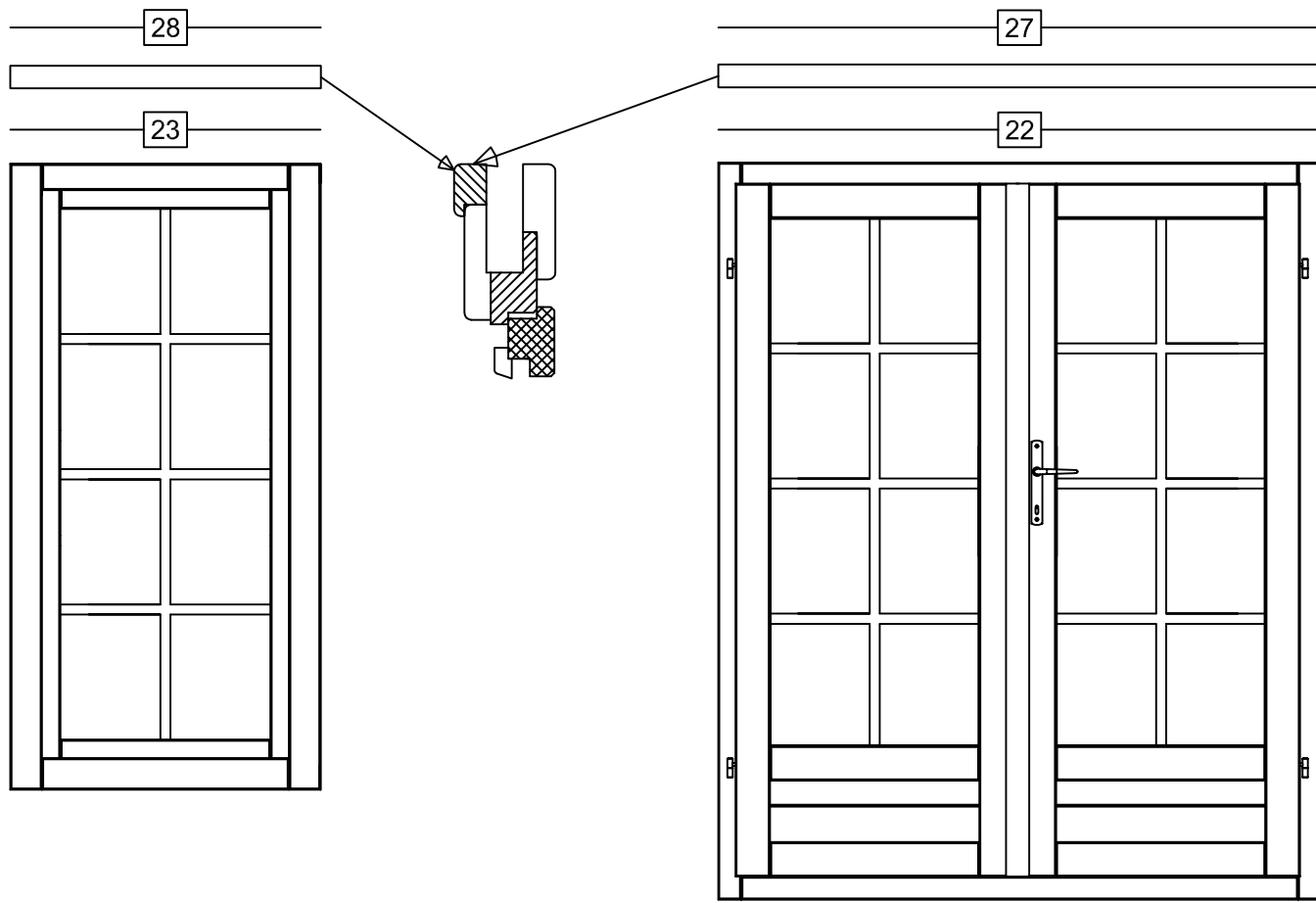



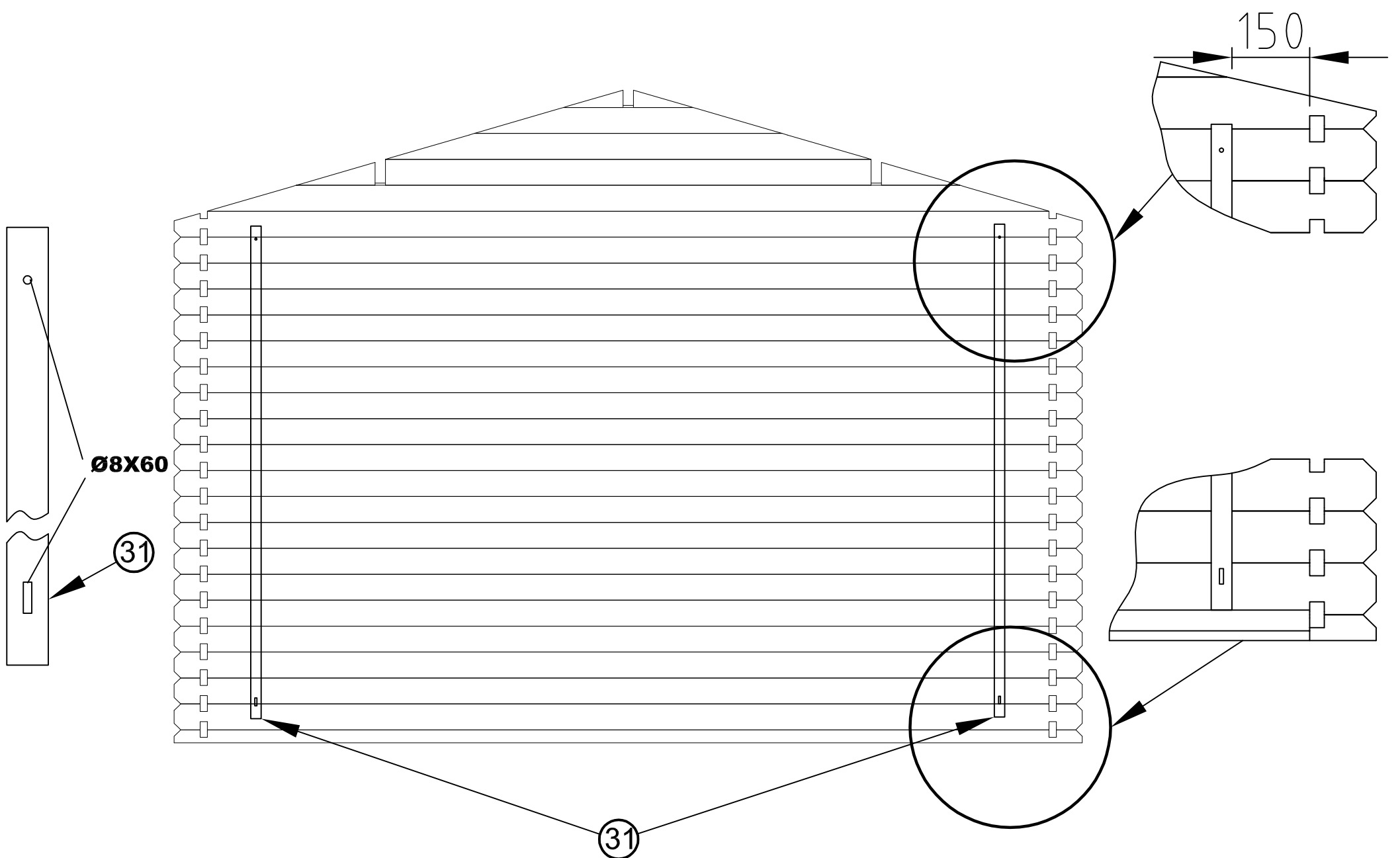



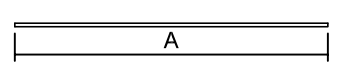
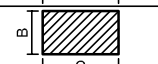
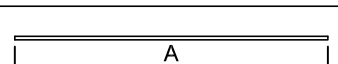
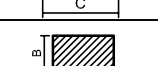
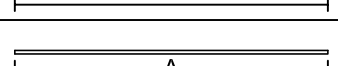
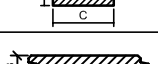
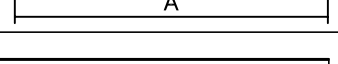

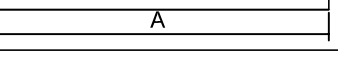

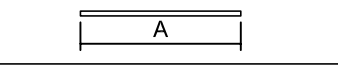
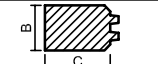
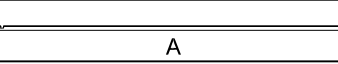

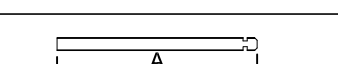
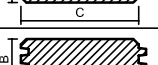

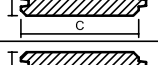

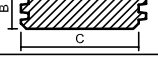
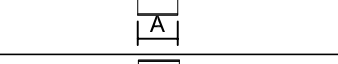
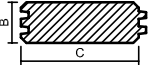
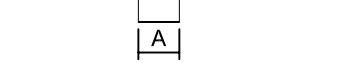
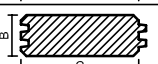
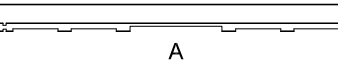
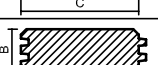
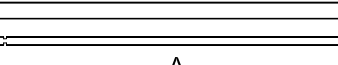
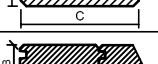

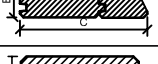
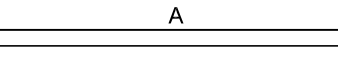

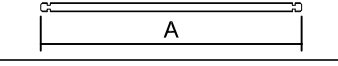
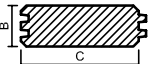
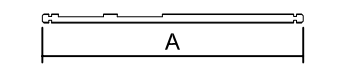
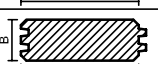
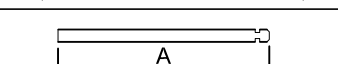
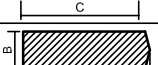
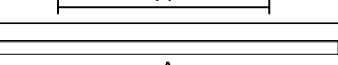
Bermuda  
Log 186  
4000x5500 45mm

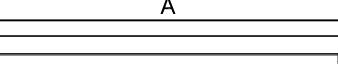
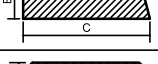
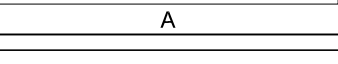
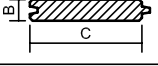
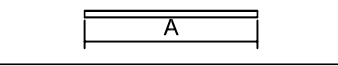
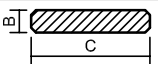
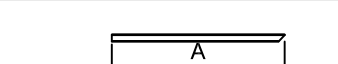
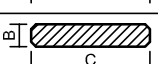
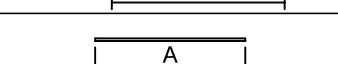
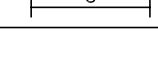
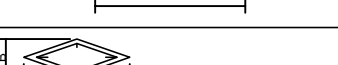
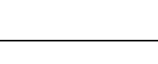
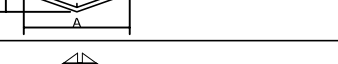

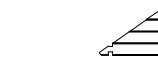
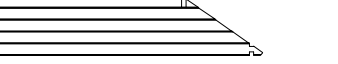
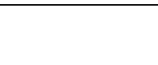
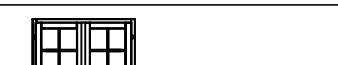
Door and window extra part above is longer  
must be cut in the construction site

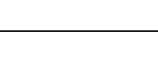
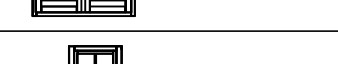

Bermuda Log 186 4000x5500m 45mm		400x550 cm			BE 2013		-Date-
		45mm 2011.12.08					
Degree < 55°		Dimensions, mm			Pos.	Quantity	
		A	B	C			
		5160	40	70	1	2	-Packing Nr.-
		3800	40	70	1a	2	
		5160	40	55	2	7	
		3700	28 !	100/130	3	53/41	
			19	24	4	~20 meters	
		5500	45	65	5	2	
		2045	45	130	6	4	
		250	45	130	7	48	
		205	45	130	8	24	
		210	45	130	9	48	
		5500	45	130	10	1	
		5500	45	130	11	15	
		5700	45	195	12	2	
		4000	45	130	13	6	
		4000	45	130	14	2	
		2160	45	130	15	24	
		5700	58	200	16	1 < 55° !	
		5700	58	200	17	4 < 55° !	
		2530	19	100/86	18	114/134	
		2580	19	90	19	4 < 55°	
		1900	19	90	20	6	
		200	70		21	3	
		4000	1412			2	
		1410	1900		22	1	
		690	1600		23	8	
					24	1	
					25	2	
		1501	19	100	26	2 !	
		~1510	28	45	27	1	
		~790	28	45	28	1	
		1501	19	40	29	2	
		2530	19	40	30	4	
		ca. 1880	19	40	31	4	
<b>Constructor: K.Jokšas</b>						Page 1/1	

-Packing Nr.-

-Name, last name-

-Signature-