

5 Drawer Chest

1010201
1010202
1010211

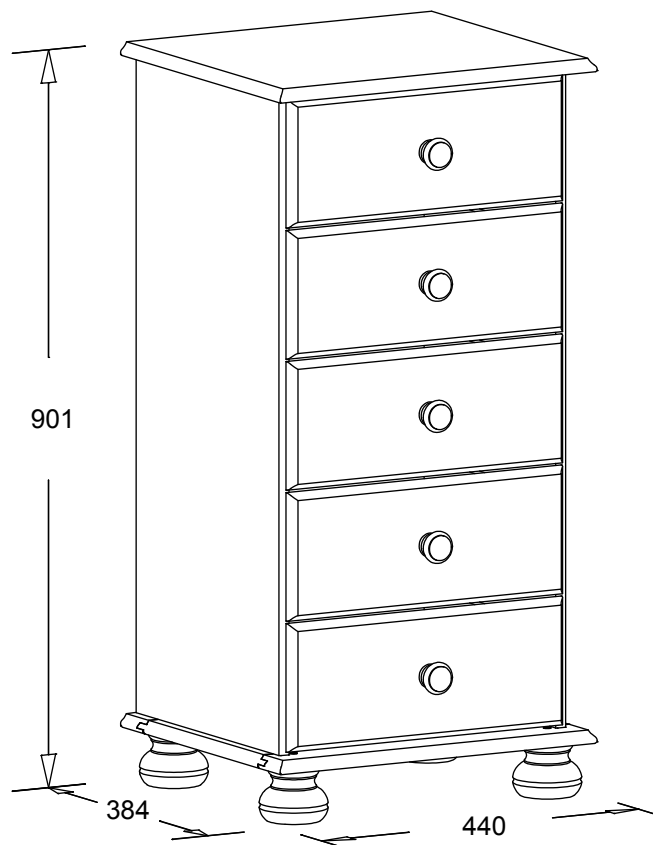

Important!

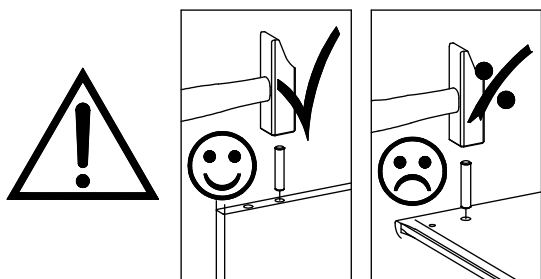

Please, read the assembly instruction carefully, before assembling.

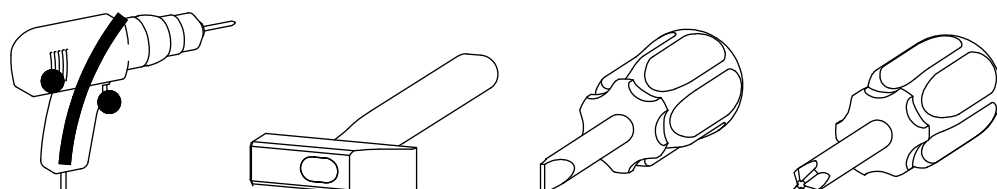

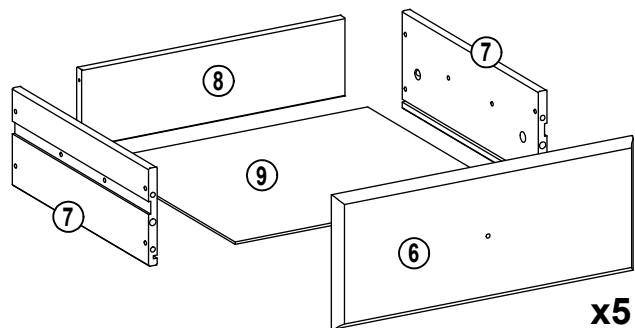
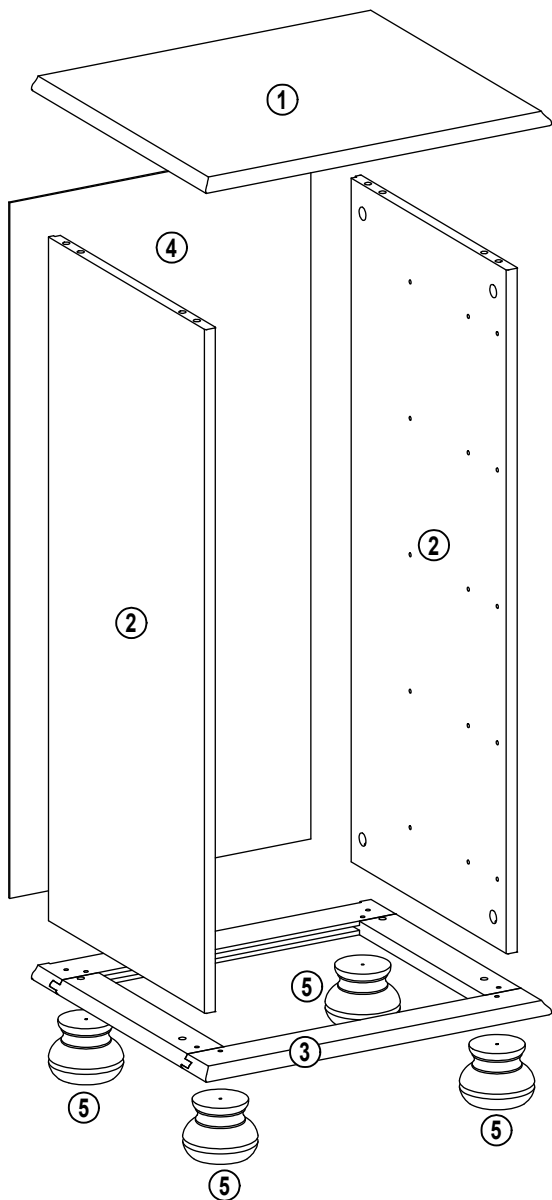

	Aa $\varnothing 8 \times 40\text{mm}$ 8 x	Ab $\varnothing 6 \times 30\text{mm}$ 20 x	Ba $\varnothing 3,5 \times 35\text{mm}$ 20 x	Bh $\varnothing 4 \times 40\text{mm}$ 4 x	Ca $\varnothing 15 \times 10,5\text{mm}$ 8 x	
	Cb $\varnothing 5 \times 8, \text{cc}34\text{mm}$ 18 x	Cq $\varnothing 12 \times 9,5\text{mm}$ 10 x	Di $1,2 \times 15\text{mm}$ 50 x	Gn $\varnothing 39 \times 30\text{mm}$ 5 x	Ha M4 x 10mm 10 x	
	Jc $\varnothing 4 \times 35\text{mm}$ 5 x	Kb $\varnothing 5,8 \times 8\text{mm}$ 30 x	Sk $246 \times 17 \times 10\text{mm}$ 10 x			

1

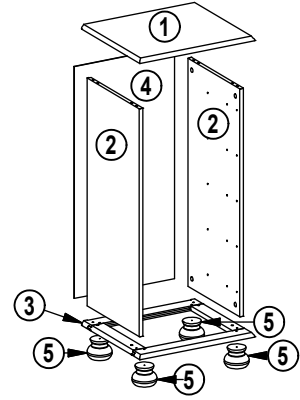
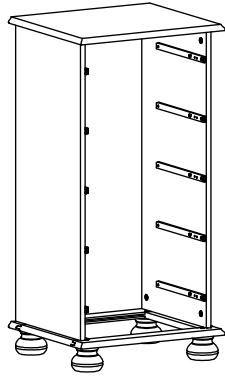

1.1

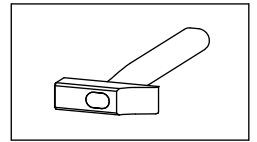
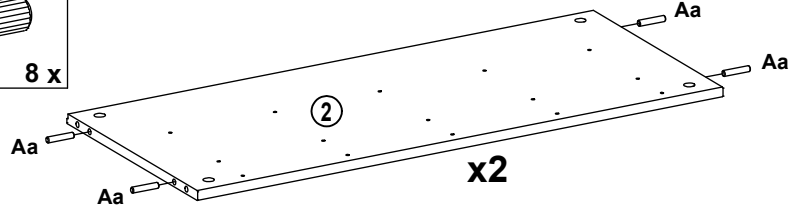
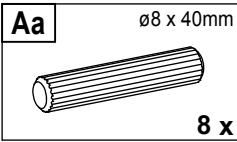

1.2

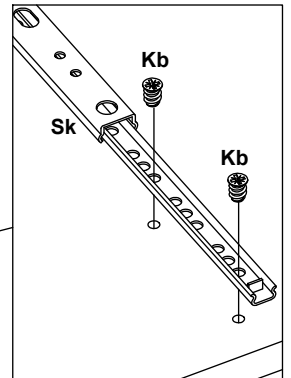
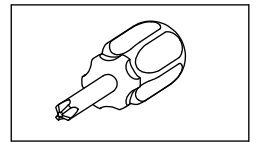
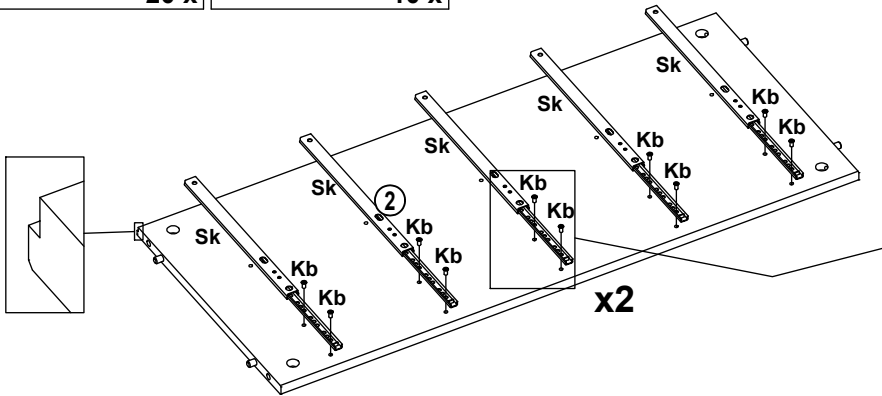
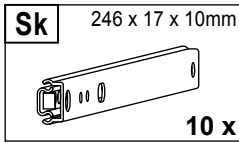
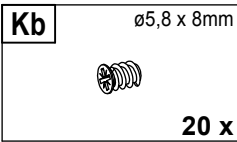

1.3

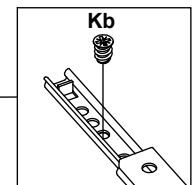
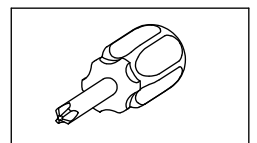
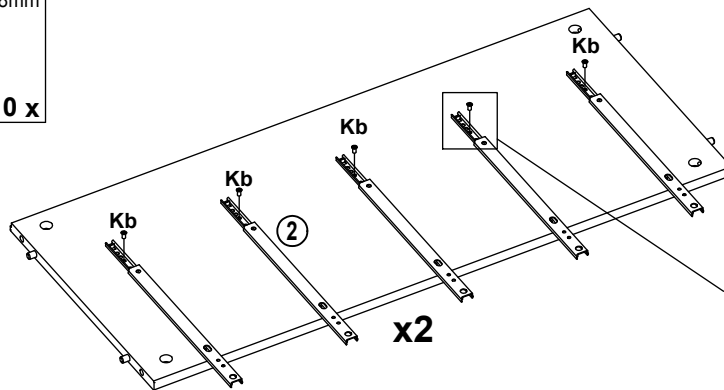
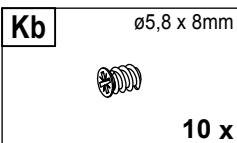

1.4

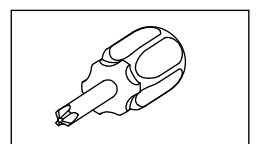
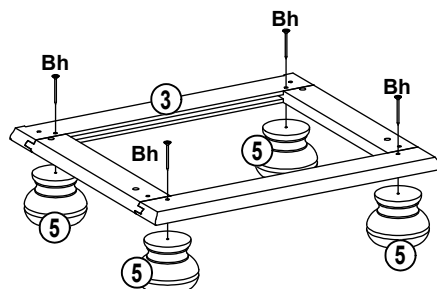
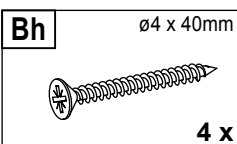

1.5

Cb $\varnothing 5 \times 8, cc34mm$
8 x

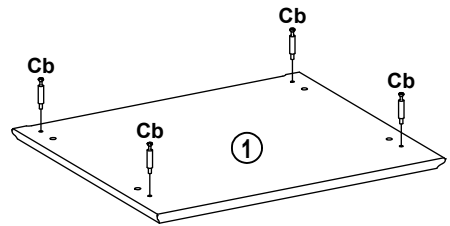
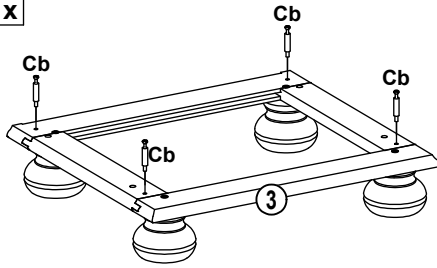
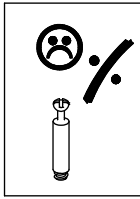
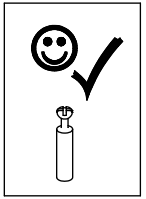
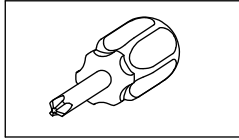

1.6

Ca $\varnothing 15 \times 10,5mm$
8 x

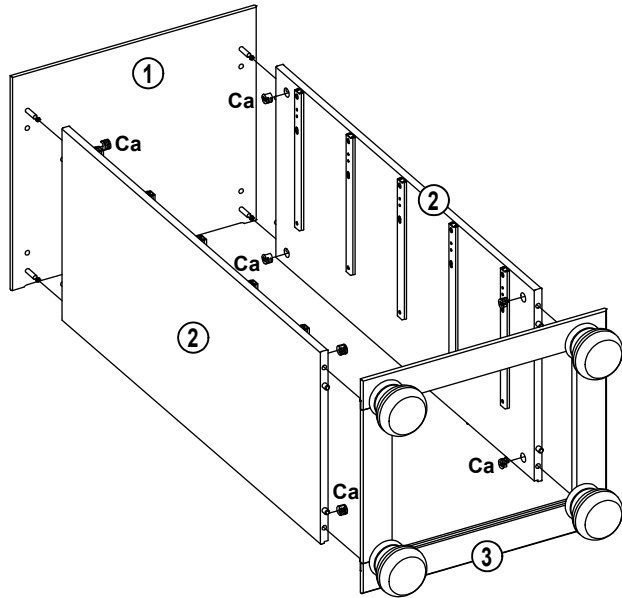
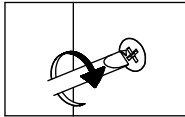
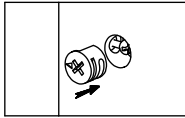
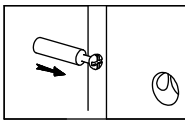
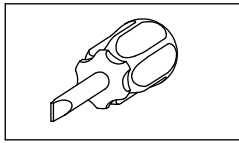

1.7

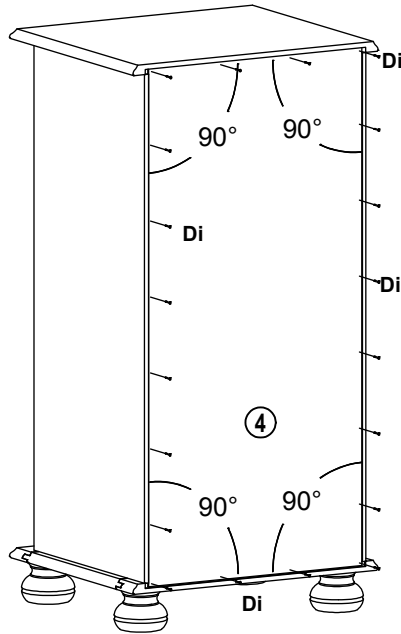
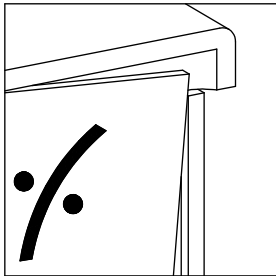
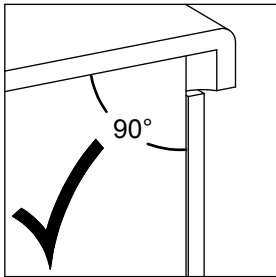

Di 1,2 x 15mm
20 x

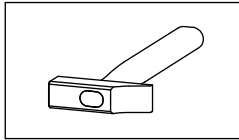

1.8

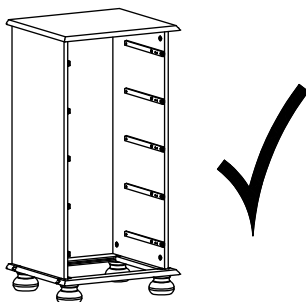

2

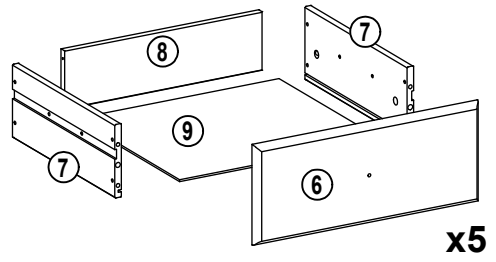
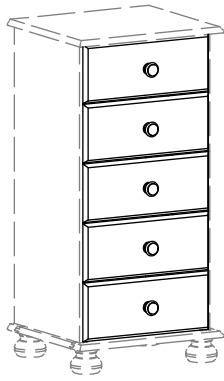

2.1

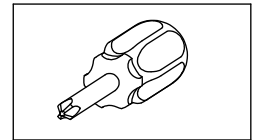
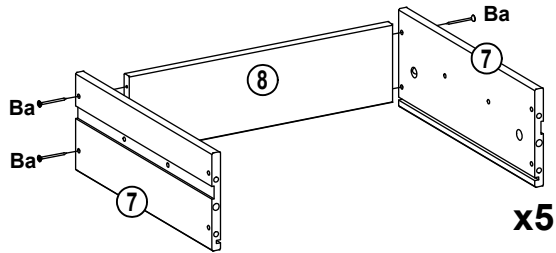
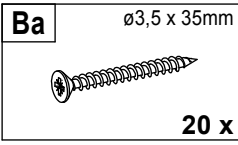

2.2

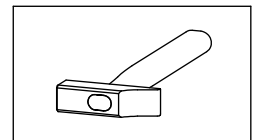
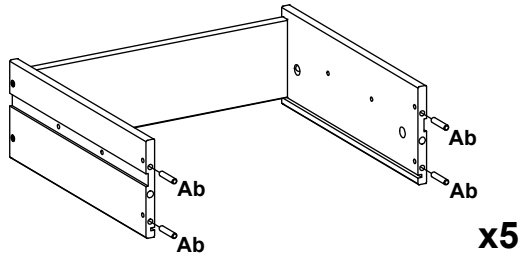
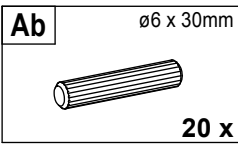

2.3

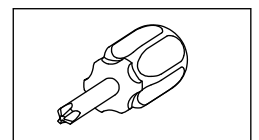
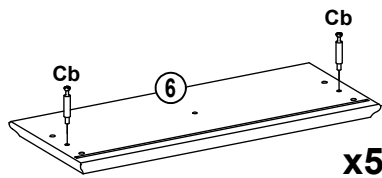
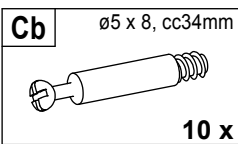

2.4

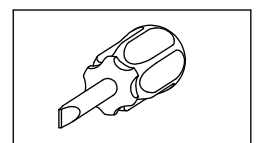
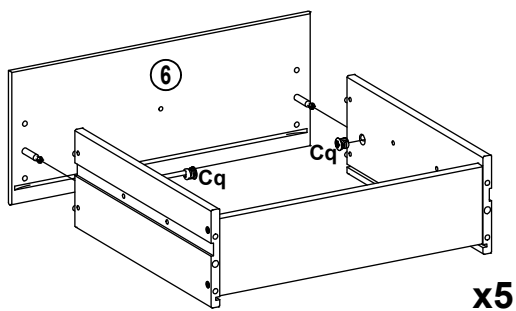
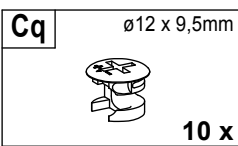

2.5

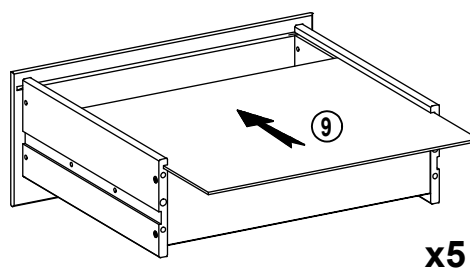

2.6

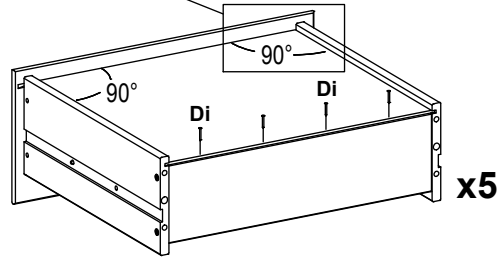
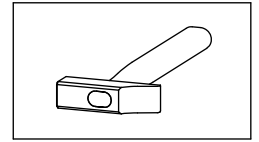
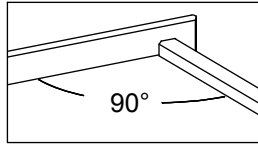
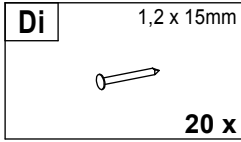

2.7

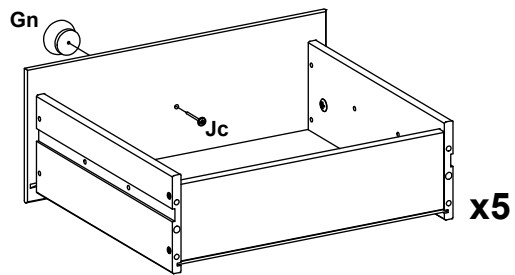
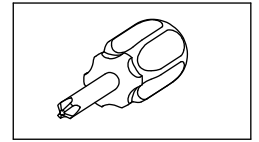
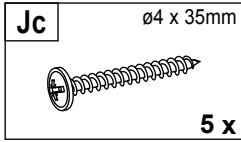
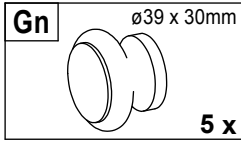

2.8

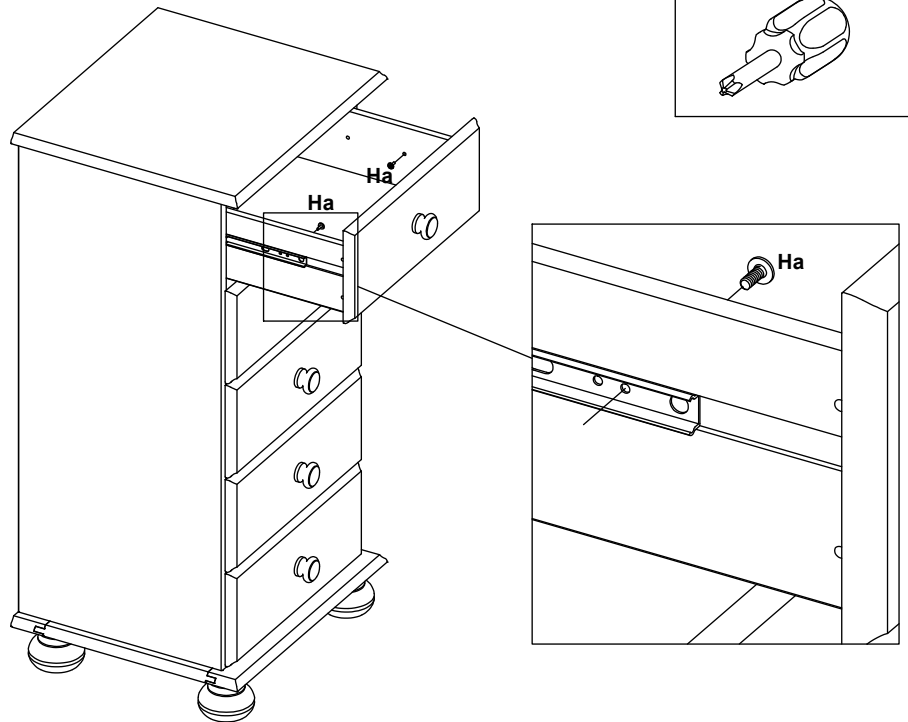
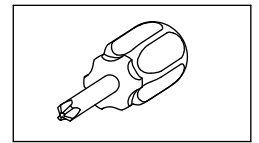
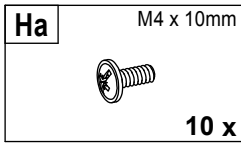

2.9

